



Natural wood
Made to last

Installation Guide Decking

2020-12-15



Installation Guide

Kebony

Kebony supplies decking materials for installation in Use Class 3 (EN 335) for outdoor use above the ground and not in contact with the soil. This guide provides instructions for installing Kebony decking so as to produce an attractive and durable result. Local conditions and building regulations must always be taken into account. The guide assumes that the installer has the necessary professional competence.

Kebony is a modified wood product in which the timber's properties are permanently changed and enhanced through an eco-friendly process without the use of environmental toxins. Our process yields a stable, hardwearing, long-lasting and beautiful decking material.

Use the principles of constructive wood protection for the entire construction and solutions for untreated timber outdoors. Pay particular attention to the design and execution in respect of end grain and ventilation, and avoid moisture traps. In this guide, we show examples of good solutions that adhere to these principles.

Kebony products must be stored dry until they are installed. It is recommended to keep the materials covered in plastic until use.

Appearance

Kebony decking has a dark brown colour when supplied. Once the decking has been exposed to rain and sunlight over time, the surface will change and develop a natural silver-grey patina. Since the effects of weather around a building can vary, there will also be variation in how the wood changes colour.

Surface cracks and fissures are natural in timber that is installed outdoors without surface treatment. Initially, the runoff of rain from a Kebony surface will have a dark colour that may be visible on some light surfaces.

Timber and Metal

Kebony can be combined with stainless and acid-proof steel, enamelled or coated fittings and aluminum without the timber becoming discoloured. When using other combinations, the runoff from Kebony timber may cause discolouration and corrosion. For example, zinc fittings can corrode, while copper ones will remain bright where exposed to runoff from the wood. Runoff from galvanised or ferrous metals onto Kebony will result in a dark discolouration of the wood.

Fastenings in contact with the timber must be made from acid-proof (A4) or stainless (A2) steel. A4 is generally recommended and must always be used in coastal areas and chloride environments; A2 must only be used in less corrosive environments. Screws of a different quality or use of A2 in the wrong environment may result in dark discolouration around the screwholes.

Key points: Kebony decking

This page presents the key points involved in the installation of Kebony Character and Kebony Clear decking. The guide goes into more detail on the following pages, so it is important to read it right through.

Use the principles of constructive wood protection

- Ensure that the structure has good air circulation, to allow wet timber to quickly dry out.
- Use a slope or drainage to prevent water from pooling on or under the decking.
- Avoid details that allow moisture to accumulate in the end grain.
- Use moisture barriers between different materials.

Min 6mm spacing between the boards

Use A4 fasteners

Kebony Character

- Cut surfaces must be treated
- Must be predrilled if fastening close to the board ends
- Recommended fastening: edge screws (Camo)

Kebony Clear

- Recommended fastening for profiles without side slits: Screwed from top
- Must be predrilled
- Recommended fastening for profiles with side grooves: Kebony H-clips

Joist spacing

Maximum recommended joist spacing (c/c), ordinary deck(*)				
Wood type/Thickness	22 mm	28 mm	34 mm	38 mm
Kebony Character	-	60 cm	90 cm	-
Kebony Clear	50 cm	-	-	110 cm

* Category A, residential areas (Eurocode 1), 2.5 kN/m² uniformly distributed load, 2.0 kN concentrated load, max 5 mm deflection. For use in other areas or with higher loads, the joist spacing must be reduced.



Butt joints made over double joists prevent moisture accumulation in the end grain wood, ensure good drying out and reduce end splitting.

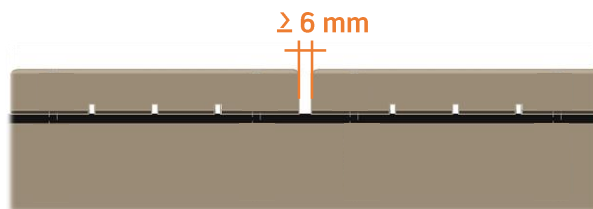

Moisture barriers protect the structure and prolong its life.

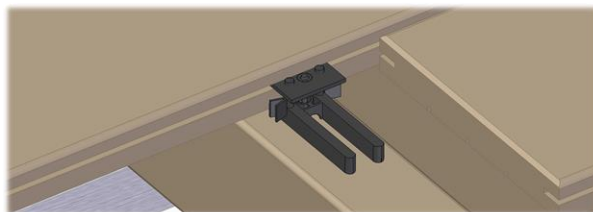

Kebony H-clips ensure the correct gap between boards, improve ventilation under the boards and prevent moisture migration.



Kebony Character Decking

Use edge fastening to avoid chipping and the accumulation of water around screw holes. This also gives a more attractive deck. For edge fastening, it is recommended to use a screw jig from Camo™ Fasteners or similar. See the supplier's guidelines.

If other fastening methods are used, it is important to avoid collecting water in the screw holes.

Position screws at least 25 mm from the board end.

Edge fastening produces an attractive and durable deck without visible fasteners.

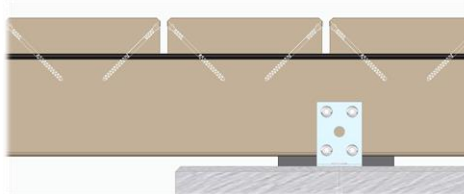

Other than cutting the boards to length, working the wood should be avoided since this will expose untreated heartwood. All cut surfaces must be treated with Kebony end-grain sealing wax, or equivalent. Follow the manufacturer's instructions.

Kebony Character may have some dimensional variation. The installation method shown under "Ends and joints" will produce a good-looking finish, even with a degree of variation.

If another method is used, it is recommended to check that ends to be joined fit together before fastening.

Kebony Character

- Cut surfaces must be treated
- Must be predrilled if fastening close to the board ends
- Recommended fastening: edge screws (Camo)

Kebony Clear Decking

Kebony Clear is supplied in profiles with or without side slits

For profiles without side slits, top fastening should be used and screwholes must be predrilled before fastening. Recommended screw sizes are 5x50 mm for 22 mm thick decking and 6x80 mm for 38 mm thick decking. Edge fastening is not recommended.

Position the screws at least 20 mm from the side of the board and at least 25 mm from its end. Do not screw the screw in too deeply; the top of the screwhead should be flush with the surface of the board.

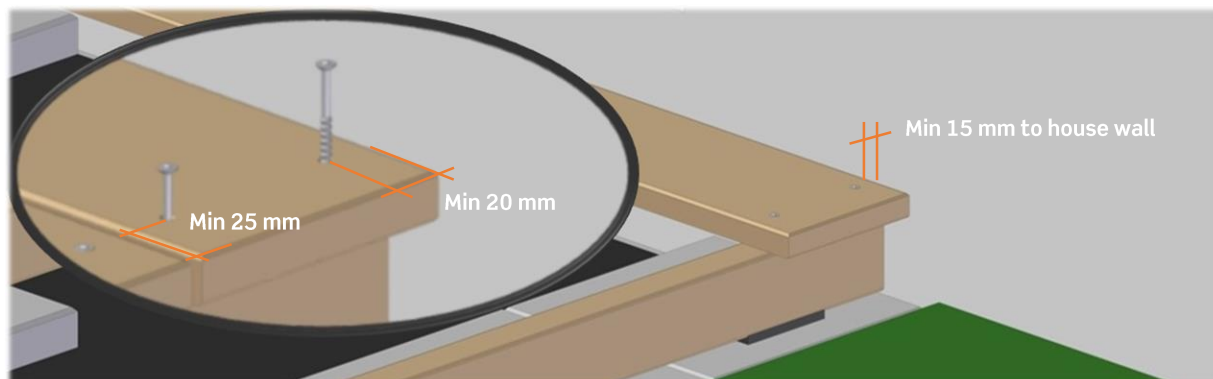

For profiles with side slits, use Kebony H clips or similar for hidden fastening. Installation using clips is described on page 12.

Kebony Clear can be worked and sanded, and can also accept plugs using a glue suitable for outdoor use.

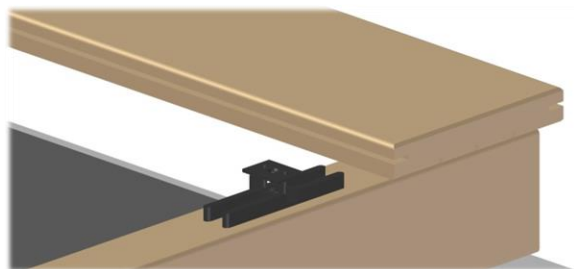

For stairways, ramps and end pieces, decking boards without side slits must be used. This will avoid breakage of the side edge and produce a better appearance. On decking subject to high traffic, with a risk of heavy loads on the edge of boards or high-concentration loads, profiles without side slits must be used.

To use hidden fastenings in such places, a plate joiner or similar can be employed to create a slot for a Kebony H-clip, and, where appropriate, Kebony End-clips can be used in end pieces. Kebony Clear Decking quickly changes in character after installation outdoors.

A surface colour change from brown to grey normally takes place over the first year, while surface cracks and fissures develop within the first months of installation. This is a natural process for timber.

Kebony Clear

- Recommended fastening for profiles without side grooves: Screwed from top
- Must be predrilled
- Recommended fastening for profiles with side grooves: Kebony H-clips

Substrate and structure

- Kebony decking can be fitted on joists of wood or aluminum with suitable fasteners.
- For structures above ground level, the supporting system must be sized in accordance with local regulations.
- For decking adjacent to buildings, the substrate must slope away from the building or be drained so that surface water is effectively removed.
- The substructure must be made from materials of equivalent or better longevity than the decking in order to ensure that the entire structure is durable.

Kebony decking boards are supplied in fixed lengths. Plan the construction to use entire lengths and make efficient use of the material. Large terraces can be divided with a crossboard or have butt joints over double joists.



Example of a terrace divided into zones. Such solutions make extremely good use of material and create an exclusive appearance. Adapt the size of the zones to the length of the decking boards, and plan the substructure before installation.

Joists

For joists, use materials with equivalent or better longevity than the decking boards to ensure the entire structure has a long life. If using materials with a shorter lifetime, this can be increased by adopting the measures below.

To prevent moisture migration in the structure, use a capillary barrier between the joists and substrate. It is also recommended to use this between the joists and the decking to protect the joists and increase the longevity of the structure. Suitable products are joist tape, sill tape, spacer blocks, rubber spacers, and so forth. Some of these products can also reduce creaking in the structure.

Where the decking boards join longitudinally, double joists installed 30-50 mm apart must be used. A decking board must always be fitted over at least three joists.



Example of use of a moisture barrier. Spacer block between concrete slab and joist. Suitable sill tape between joist and decking.



Joist tape used between decking and joists.

- To avoid water pooling on the decking boards, it is recommended they slope longitudinally.
- If the decking is built without a slope, it will require more care and maintenance.
- Use moisture barriers between different materials.

Joist cont.

Maximum recommended joist spacing (c/c), ordinary deck(*)				
Wood type/Thickness	22 mm	28 mm	34 mm	38 mm
Kebony Character	-	60 cm	90 cm	-
Kebony Clear	50 cm	-	-	110 cm



* Category A, residential areas (Eurocode 1), 2.5 kN/m² uniformly distributed load, 2.0 kN concentrated load, max 5 mm deflection. For use in other areas or with higher loads, the joist spacing must be reduced.

Joists should be used that make no more than 50 mm width of contact with the decking. The joists are attached to the substrate/substructure and stiffened. Where it is not possible to attach the joist to the substrate, a torsionally rigid structure using crossbeams must be made.

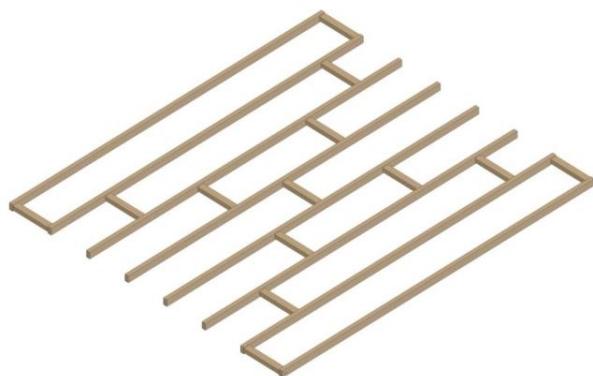

Example of stiffening of joist layer to avoid twisting.

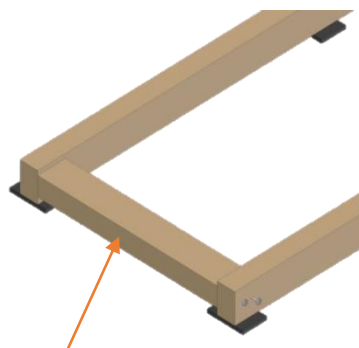

TIP: Fit the crossbeams horizontally to ensure good ventilation and drainage.

Decking on fixed substrate

Decking can be installed on joists on a fixed substrate, such as concrete, tiles, membranes and similar. The substrate must have a sufficient slope, at least 1.5%, to avoid water collecting under the decking.

For smaller decking with a concrete or membrane substrate, decking bearers can be used. A moisture barrier must be laid between the bearers and the substrate. The bearers must be laid in the direction of the slope and be no more than 3 metres long; beyond this, joists must be used. The distance from the lower edge of the decking to the substrate must be at least 40 mm.

Decking directly over the ground

The substrate must be stable and free of wet soil mass, and landscaped so that the surface water is drained or runs away from the decking.

On soft substrates and soil, geotextile fabric and a draining layer must be used, such as gravel, levelled with fine particles, at least 200 mm thick. The distance from the lower edge of the decking to the ground must be at least 100 mm.

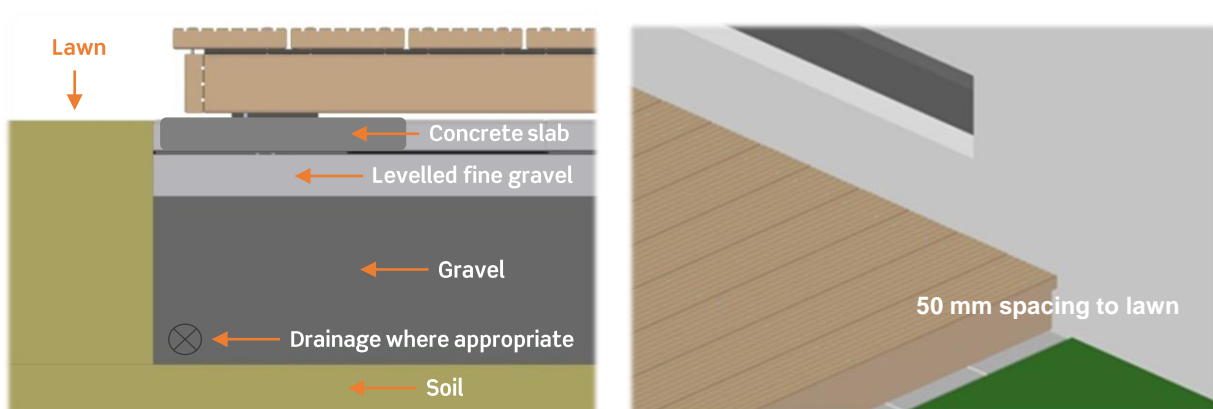

Ensure separation from grassed areas to prevent the decking boards taking up moisture. This separation could consist of kerb stones or an edge board covered with a foundation membrane.

If possible, maintain a distance of at least 50 mm from the decking to the edge of the lawn, so that it is possible to cut the lawn without damaging the woodwork.

Remember to have at least two open sides under the decking for ventilation.

Joists close to the ground must be laid on concrete slabs or similar.

Decking on fixed substrate cont.

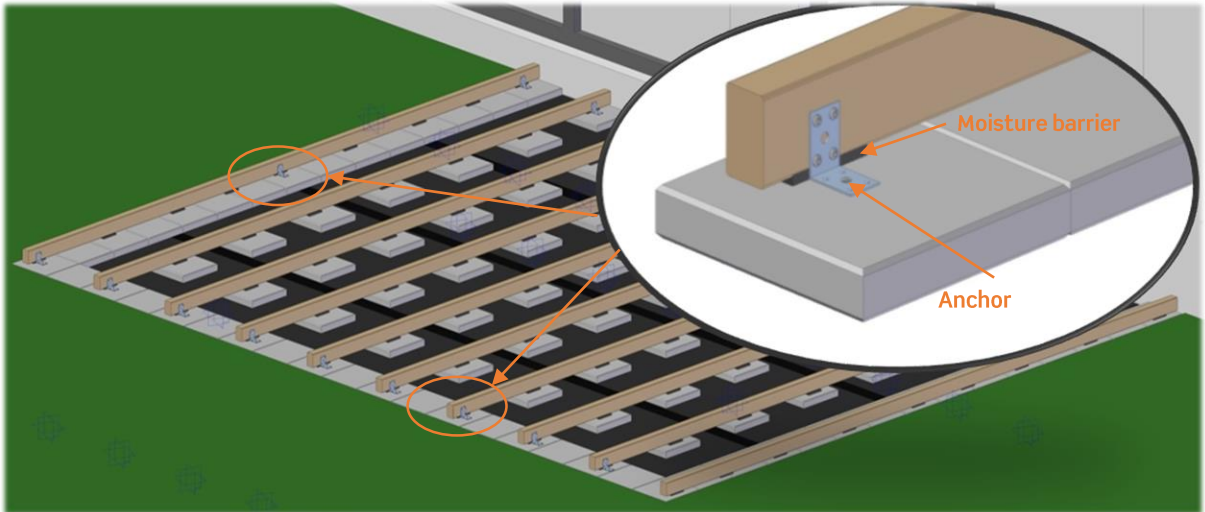

Example of joists at ground level. The joists are mounted on concrete slabs with EPDM spacers between. This acts as a moisture barrier and raises the joists above the concrete slab, preventing moisture-wicking and allowing better drying of the wood. Angle brackets are used to anchor and stiffen the joists.

Decking above ground

The sizing of the joists and support system must comply with the regulations. Cover the ground and soil mass under the decking to prevent the growth of vegetation.

Ventilation

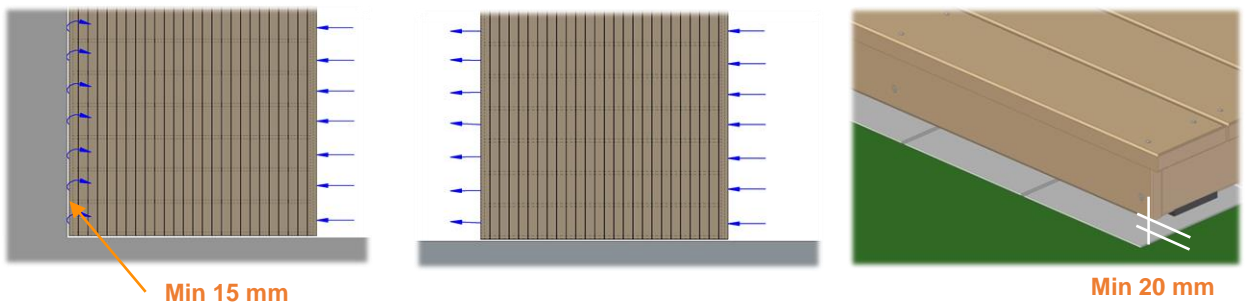

The structure below the decking must be ventilated so that wood that gets wet can quickly dry out again. This can be achieved by openings along at least two sides so that the air circulates beneath the decking. If one of the sides is against a wall, there must be an opening of at least 15 mm against it. Any edge board must finish at least 20 mm above the ground/substrate in order to allow air to circulate.

Orientation of the boards

The decking boards must be installed with the side with the rounded edges facing up. Any relief grooves will then face downwards towards the substructure.

Ventilation

Spacing gaps

Install the decking with a spacing gap of at least 6 mm between the boards.

Kebony is dried during production and some swelling must be expected when installing outdoors. This applies to both length and breadth, and will be especially visible at mitred corners if this is not allowed for.

Allow a distance of at least 5 mm from the board's edge and end to adjacent building elements and framing.

Decking installed against a building must be spaced at least 15 mm from the building.

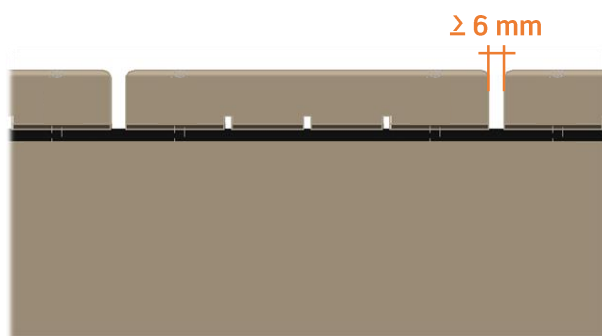

Ends and joints

For an attractive result, all ends should be finished.

Sharp edges at the ends of boards should be rounded or bevelled to reduce chipping and make the deck more comfortable to walk on.

Ends should never terminate directly above a joist, but should have an overhang for ventilation and to prevent moisture from accumulating.

Longitudinal decking joints should be made over two joists. There should be a gap of at least 5 mm between the board ends to let them dry out properly and give the wood room to expand.

In order to limit variations in moisture in the end grain, a water-repellent end grain sealer will reduce the potential for splitting.



Illustration of a joint over 2 joists. With Kebony Character, this method will produce attractive, comfortable joints even if there is variation between the ends to be joined.

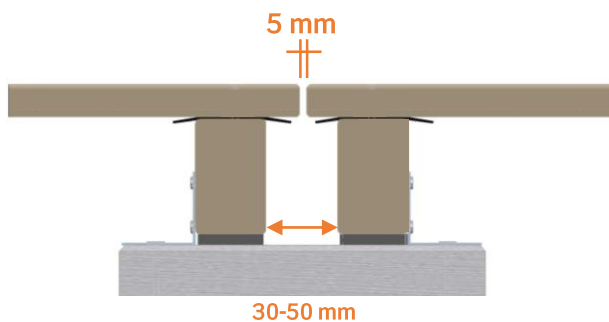

Joint that prevents accumulation of moisture and dirt in the end grain. Ensures good drying of the end grain and reduces possibility of splits. This increases longevity and simplifies cleaning.

Summary

- Use the principles of constructive wood protection
- Min 6mm spacing between the boards
- Use A4 fasteners
- Ensure that the structure has good air circulation, to allow wet timber to quickly dry out.
- Use a slope or drainage to prevent water from pooling on or under the decking.
- Avoid details that allow moisture to accumulate in the end grain.
- Use moisture barriers between different materials

Kebony Character

- Cut surfaces must be treated
- Must be predrilled if fastening close to the board ends
- Recommended fastening: edge screws (Camo)

Kebony Clear

- Recommended fastening for profiles without side slits: Screwed from top
- Must be predrilled
- Recommended fastening for profiles with side grooves: Kebony H-clips



Installation with hidden fasteners: Kebony H-clip Mounting clips

Kebony H-clips must be combined with Kebony Start- and End-clips. Kebony Start- and End-clips are available separately. The clips produce automatic spacing of 7 mm between the boards and raise the decking 10 mm above the substructure, which contributes to constructive wood protection.

The decking clips are supplied with screws suitable for a substructure of either wood or aluminium (specify when ordering). When using start clips, the minimum recommended width of the joists is 45 mm. The supplied screws are not suitable for screwing the decking from the top.

When using decking clips, the boards are held down onto the substructure, but they are not locked longitudinally. To secure the boards against longitudinal movement, Kebony End-clips can be fastened in the centre under the board, or alternatively the boards can be screwed from the top.

Installation of the first row

Check that the boards in the first row are straight. Fit them using start clips and associated holders. (If the edge is not visible, an H-clip can often be used)

First, screw a holder into each joist in a straight line, using the supplied screws (4x25 mm). Make sure that the little arrow on the holder's uppermost end points in the direction in which the decking is to be laid (figure 1).

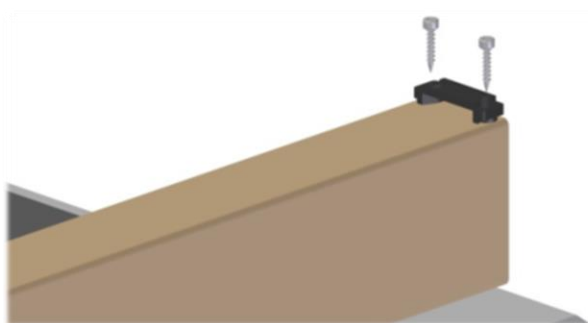

Figure 1: Install one holder on each joist

Lay the first board on the substructure and mark the middle of each holder. Then fit the start clips on the underside of the first board. Pre-drilling is recommended.

The lip of the clip must be 3 mm from the edge of the board (figure 2).

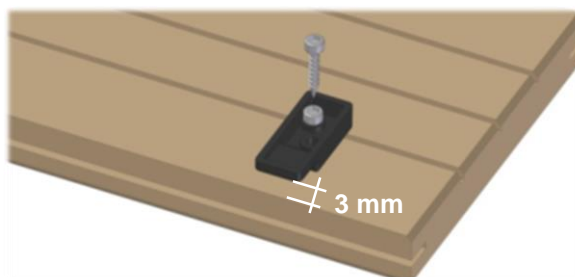

Figure 2: Fit the start clip on the underside of the first board.

Once all the clips have been fitted, lay the board downwards on the substructure and push the lips into the holders (figure 3).

Note: do not push too hard.



Figure 3: Fit the board on the substructure and press the lips into the holders.

Installation with hidden fasteners cont..

Installation of subsequent boards

Once the first board has been pushed into place, push the decking clips into place underneath it.

Place one decking clip on each joist. Do not screw on the decking clips yet.

Push board number two against the first board. Then push new decking clips in place, one for each joist.

The stem of the clip produces a space of 7 mm, but it is recommended to use a spacing block as an aid (figure 4).

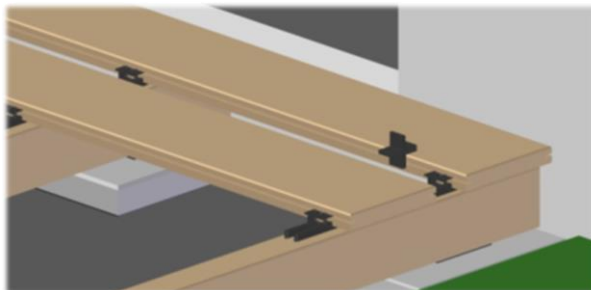

Figure 4: Use spacers to ensure the correct distance between the boards.

Fasten the first row with H-clips (figure 5). Install the subsequent boards in the same way.

Any boards with a slight bow can be held down using a cargo strap or clamp to assist with installation.

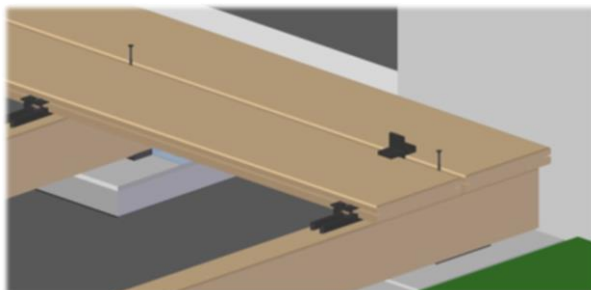

Figure 5: Do not screw the decking clips in before the next board is correctly placed.

Installation of the last board

The outer side groove of the last decking board should be sawn off to prevent breakage; alternatively, use a profile without a side groove.

Lay the board on the substructure, with the bottom side up. Mark the decking board where it rests on the substructure.

The thicker (10 mm) part of the Kebony End-clip is screwed to the decking board, so that it acts as a spacer – one clip for each joist (figure 6).

Predrilling is recommended.

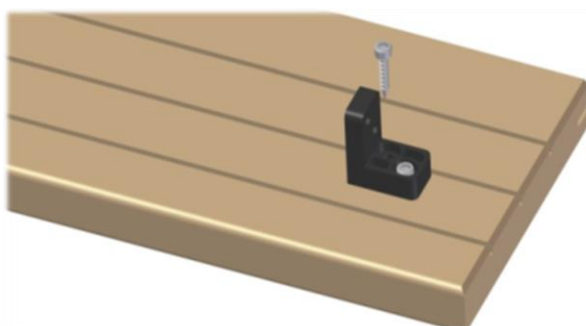

Figure 6: Fasten the thicker part of the end clip to the underside of the decking board – one clip per joist.

Installation with hidden fasteners cont..

Lay the board on the substructure and push it into place (figure 7).

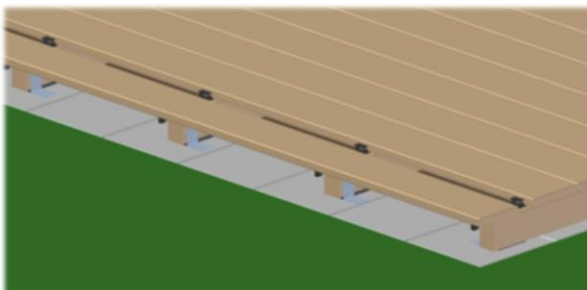

Figure 7: Push the board into place.

The end clip is screwed to the substructure from the side, using the supplied screws (4x25 mm) (figure 8).

Attach the last row with Kebony H-clips.



Figure 8: Screw the end clip to the substructure.

Jointing boards

If boards need to be jointed longitudinally, do this over double joists using two clips (figure 9).

The joists must be 30-50 mm apart.
A gap in the joint of 3-5 mm is recommended

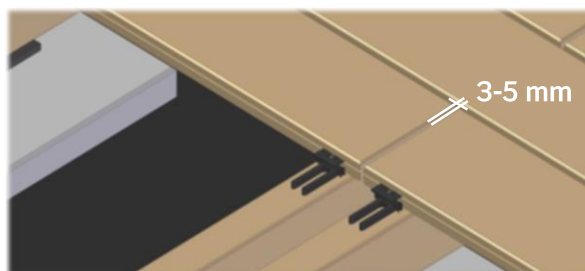

Figure 9: Jointing of boards over double joists.